

**WE-1550-YZ-CW Series High-power Optical Amplifier (With PON Port)**



**1 Product Overview**

WE-1550-YZ-CW optical amplifier uses well-known high-performance erbium-ytterbium co-doped double-clad fiber and low-noise pump laser. It has a reliable circuit design and efficient heat dissipation design. The maximum total output power of the whole machine can reach +37dBm, and it supports up to 16 outputs, with optional optical switch, CWDM, and RF detection. It provides SNMP protocol network management software and WEB network management, suitable for amplified transmission of downstream 1550nm optical signal in FTTH network.

**2 Block diagram**

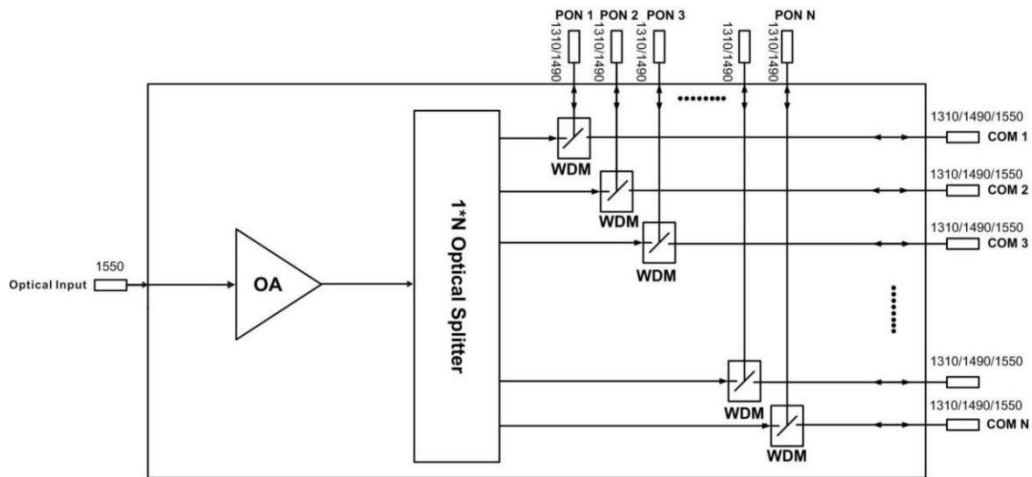

**3 Technique Parameter**

Item	Unit	Technique parameters	Remark
CATV pass through wavelength	nm	1545 - 1565	
PON pass through wavelength	nm	1260 – 1360 & 1480 - 1500	
PON insertion loss	dB	<0.8	
Isolation	dB	>30	
Optical input power range	dBm	-5 ~ +10	
Maximum optical output power	dBm	37	
Output power stability	dBm	±0.5	
Noise figure	dB	≤ 6.0	Optical input power 0dBm, λ=1550nm
Return loss	Input	dB	≥ 45
	Output	dB	≥ 45
Optical Connector Type		INPUT port: SC/APC	
		PON port: SC/UPC or LC/UPC	
		COM port: SC/APC or LC/APC	
C/N	dB	≥ 50	Test condition

C/CTB	dB	≥ 63	according to GT/T 184-2002
C/CSO	dB	≥ 63	
Power supply voltage	V	A:AC160V - 250V (50 Hz) ; B:DC48V	
Consumption	W	≤ 65	
Operating temperature range	°C	-10 - +45	
Maximum operating relative humidity	%	Max 95% No Condensation	
Storage temperature range	°C	-30 - +70	
Maximum storage relative humidity	%	Max 95% No Condensation	
Dimension	mm	437(L)× 442(W)×44(H)	

## 4 External Function Description

### 4.1 Front Panel Description

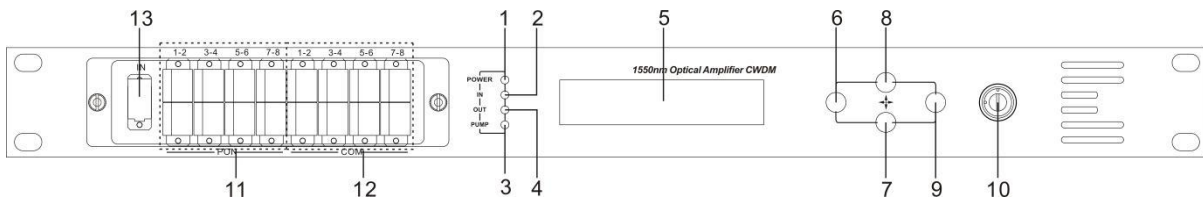

1. Power indicator: One switching power supply is working – yellow; two switching power supplies are working – green.
2. Optical input power indicator: This light turns on when the optical input power is > -10dBm.
3. Pump working status indicator: Red light means the pump is not working; Flashing red light means the machine has broken down; Green light means the pump is working normal.
4. Optical output power indicator: This light turns on when the optical output power is > +10dBm.
5. 160×32 dot-matrix LCD screen
6. Display the exit or cancel key of the setup menu.
7. Display the down or decrease key of the setup menu.
8. Display the up or increase key of the setup menu.
9. Display the enter key of the setup menu.
10. Pump laser switching key: “ON” means the pump laser is open and “OFF” means the pump laser is closed. Ensure the key is on “OFF” position before power on. After passing self-test, rotate the key to “ON” position according to the displayed message.
11. PON port
12. Public port (COM port)
13. Optical signal input

### 4.2 Rear Panel Description

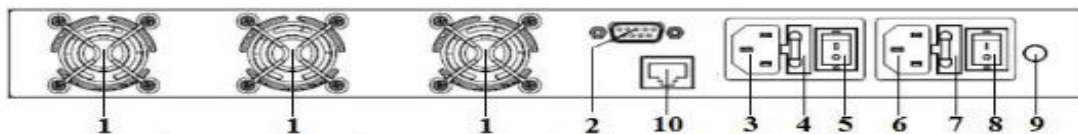

1. Fan outlet.	2. RS232 interface.
3. The AC 220V input port of power supply 1.	4. The fuse of power supply 1.
5. The switch of power supply 1.	6. The AC 220V input port of power supply 2.
7. The fuse of power supply 2.	8. The switch of power supply 2.
9. Ground stud of the chassis	10. LAN interface

## 4.3 DC Power Introduction

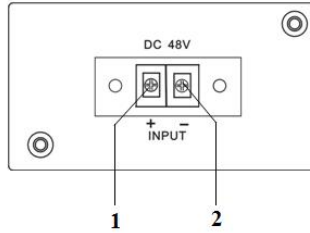

1	+ Positive terminal block
2	- Negative terminal block

## 5 Menu System

### 5.1 Main Menu

Name	Display	Description
System Starting	xxxxxxx	Manufacturers' logo
	xxxxxxx	Equipment model
	xxxxxxx	Start countdown / lock status
Suspend Page	In: xx.x out: xx.x Unit: dBm	Display the optical input / output power
Main Page	1.Disp Parameters	Entry of parameter display menu
	2.Set Parameters	Entry of parameter setup menu
	3.Alarm Status	Entry of alarm information menu

### 5.2 Display Menu

Input Power: xx.x dBm	Input power, accurate to 0.1 dBm
Output Power: xx.x dBm	Output power, accurate to 0.1 dBm
Pump1 Power: xx.x dBm	Power of pump1, accurate to 0.1 dBm
Pump1 Bias: x.x A	Bias current of pump1, accurate to 0.1 A
Pump1 Temper: xx.x°C	Temperature of pump1, accurate to 0.1°C
Pump1 Cooling: x.xx A	Cooling current of pump1, accurate to 0.01 A
Pump2 Vol: x.x V	Drive voltage of pump2, accurate to 0.1 V
Pump2 Bias: x.x A	Bias current of pump2, accurate to 0.1 A
Pump2 Temper: xx.x °C	Temperature of pump2, accurate to 0.1 °C
Pump2 Tec Vol: x.x V	Cooling voltage of pump2, accurate to 0.1 V
Pump2 Cooling: x.xx A	Cooling current of pump2, accurate to 0.01 A
TEC Vol: x.x V	The first stage voltage of pump2 cooler, 0.1 V
+5V Read: x.x V	+5V power supply voltage , accurate to 0.1 V
-5V Read: -x.x V	-5V power supply voltage , accurate to 0.1 V
Box Temper: xx.x °C	Box temperature, accurate to 0.1 °C
S/N: xxxxxxxx	Device serial number
IP Address: xxx.xxx.xxx.xxx	IP address
Subnet Mask:xxx.xxx.xxx.xxx	Subnet mask
Net Gateway:xxx.xxx.xxx.xxx	Gateway
Mac: xxxxxxxxxxxx	Physical address
Trap1: xxx.xxx.xxx.xxx	trap1 address
Trap2: xxx.xxx.xxx.xxx	trap2 address
Software Version: Vx.xx.x.x	Firmware version number

### 5.3 Setup Menu

Set Low Input Threshold	Set the low optical input power alarm threshold, range -5.0~10.0dBm
Set High Input Threshold	Set the high optical input power alarm threshold , range -5.0~10.0dBm
Set Output ATT	Set the optical output power attenuation
Set Local IP Addr	Set IP address
Set Subnet Mask	Set subnet mask
Set Gateway	Set gateway
Set Trap1 Address	Set trap1
Set Trap2 Address	Set trap2
Set Buzzer cfg	Set the switch of beeper
Restore Factory config	Restore the factory configuration, set content as shown above

### 5.4 Warning menu

Input Status: xxx	xxx= LOLOW:	Very low optical input power alarm
	xxx= LOW:	Low optical input power alarm
	xxx= HIGH:	High optical input power alarm
	xxx= HIHIGH:	Very high optical input power alarm
Output Status: xxx	xxx= LOLOW:	Very low optical output power alarm
	xxx= LOW:	Low optical output power alarm
	xxx= HIGH:	High optical output power alarm
	xxx= HIHIGH:	Very high optical output power alarm
Pumpx Power: xxx	xxx= LOLOW:	Very low power of pump x alarm
	xxx= LOW:	Low power of pump x alarm
	xxx= HIGH:	High power of pump x alarm
	xxx= HIHIGH:	Very high power of pump x alarm
Pumpx Bias: xxx	xxx= LOLOW:	Very low bias current of pump x alarm
	xxx= LOW:	Low bias current of pump x alarm
	xxx= HIGH:	High bias current of pump x alarm
	xxx= HIHIGH:	Very high bias current of pump x alarm
Pumpx Temper: xxx	xxx= LOLOW:	Very low temperature of pump x alarm
	xxx= LOW:	Low temperature of pump x alarm
	xxx= HIGH:	High temperature of pump x alarm
	xxx= HIHIGH:	Very high temperature of pump x alarm
Pumpx Tec: xxx	xxx= LOLOW:	Very low cooling current of pump x alarm
	xxx= LOW:	Low cooling current of pump x alarm
	xxx= HIGH:	High cooling current of pump x alarm
	xxx= HIHIGH:	Very high cooling current of pump x alarm
+5V Status: xxx	xxx= LOLOW:	Very low +5V DC power supply alarm
	xxx= LOW:	Low +5V DC power supply alarm
	xxx= HIGH:	High +5V DC power supply alarm
	xxx= HIHIGH:	Very high +5V DC power supply alarm
-5V Status: xxx	xxx= LOLOW:	Very low -5V DC power supply alarm

	xxx= LOW:	Low -5V DC power supply alarm
	xxx= HIGH:	High -5V DC power supply alarm
	xxx= HIHIGH:	Very high -5V DC power supply alarm
Device Temper: xxx	xxx= LOLOW:	Very low chassis temperature alarm
	xxx= LOW:	Low chassis temperature alarm
	xxx= HIGH:	High chassis temperature alarm
	xxx= HIHIGH:	Very high chassis temperature alarm

**6.Communication Setup Descriptions**

**6.1 Communication Interface Description**

- 1) RS232 communication interface adopts DB9 standard connector, the pin definitions as follow:

The serial communication uses the standard NRZ form, 1 starts bit, 8 data bits, 1 stop bit and the baud rate is 38400.

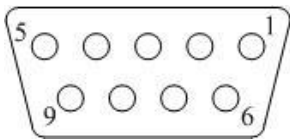

1: No Connect	2: TX	3: RX
4: No Connect	5: GND	6: No Connect
7: No Connect	8: No Connect	9: No Connect

- 2) LAN communication interface adopts RJ45 standard connector, the pin definitions as follow:

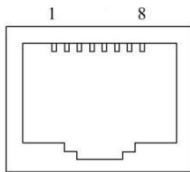

LAN

1: TX+	2: TX-	3: RX+
4: No Connect	5: No Connect	6: RX-
7: No Connect	8: No Connect	

**6.2 WEB Network Management**

1. Opening the IE browser and entering the equipment IP address leads to the following interface:

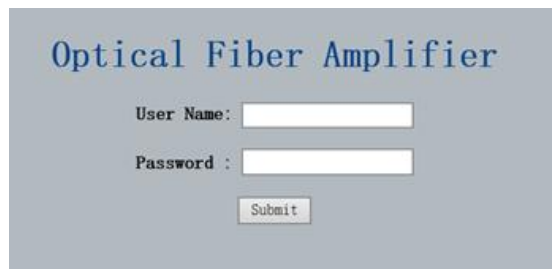

2. Enter the user name **admin** and password **123456** (factory default), to show the following interface:

*Optical Fiber Amplifier*

- *Display Parameter*
- *Set Parameter*
- *Modify Password*

**Display Parameter**

Item	Value
Device Model:	
Serial Number:	20111028
Pump Number:	2
Input Power:	7.6 dBm
Output Power:	-99.9 dBm
Pump1 Power:	-99.9 dBm
Pump1 Bias:	0 mA
Pump1 Temperature:	25.0 °C
Pump1 Cooling:	0 mA
Pump2 Bias:	0 mA
Pump2 Vol:	19.7 V
+5V:	5.0 V
-5V:	-5.2 V
Device Temperature:	18 °C
MAC Address:	30.71.b2.60.0c.fc

There are 3 sub-interfaces:

1. **Display Parameter** interface: Describes the equipment display menu.
2. **Set Parameter** interface: Change the equipment parameters in this interface.
3. **Modify password** interface: Change the login password in this interface.

3. Click **Set Parameter** to open the following interface:

### Optical Fiber Amplifier

- Display Parameter
- Set Parameter
- Modify Password

**Set Parameter**

---

Module Parameter

Item	Current	New	Update
Output ATT:	0.0 dB	0 ▾ dB	Update

Set IP Parameter

Item	Current	New	Update
Trap Address1:	192.168.1.58	<input style="width: 80%;" type="text"/>	Update
Trap Address2:	192.168.1.69	<input style="width: 80%;" type="text"/>	Update

The **Item** shows the changeable parameters, **Current**—the current parameters; **New**—select or enter the new parameters; **Update**—update the parameters.

The update steps: Find the item which needs to be changed, select a new value, and click the **Update** button.

## 7 Attention

- Ensure the package is not defaced. If the equipment is damaged due to transportation or other reasons, please don't electrify to avoid worse damage.
- Before powering on, make sure that the grounding terminals of the chassis and power socket are reliably grounded, and the grounding resistance should be  $<4\Omega$ , which can effectively protect against surges and static electricity.
- Optical amplifier is a highly technical professional equipment, its installation and debugging must be operated by professional technicians. Read this manual carefully before operating to avoid damage to equipment caused by fault operation or accident harm to the operator.
- When installing and debugging optical equipment, invisible laser beams may be emitted inside the fiber connector. Avoiding permanent harm to the body and eye, the fiber connector should not aim at the human body and human should not look directly at the fiber connector with the naked eye!
- There must be no shielding outside the ventilation holes of the device. Poor ventilation will cause the index to decrease, and in serious cases will cause damage to the device.
- When cleaning the fiber end face, you must confirm that the optical source is turned off.
- When the fiber connector is not in use, put a dust cover to avoid dust pollution and keep the end surface of the optical fiber clean.
- When installing the fiber connector, apply appropriate force to avoid damage to the adapter. Otherwise, the output optical power may decrease.



Hangzhou Prevail Communication Technology Co.,LTD.

Hangzhou Prevail Optoelectronic Equipment Co.,LTD.

Both **PREVAIL** and **Prevail** are registered trademarks of our company.